



Equipos, partes y accesorios de tecnología informática y servicios de soporte técnico

Cotización No. 001 - 41

NIT	CLIENTE	CONTACTO	FECHA	CIUDAD
TELÉFONO	DIRECCIÓN	EMAIL	DESCUENTO	FORMA DE PAGO

Atendiendo a su amable solicitud, enviamos la cotización de los productos solicitados por su organización:

ITEM	CÓDIGO	DESCRIPCIÓN	CANTIDAD	VR. UNITARIO	VR. TOTAL
1		KIT11 : 8 CAMARAS DE METAL HD	1	S/. 1,593.22	S/. 1,593.22
2		Camara Interior HK-DS2CE56C0T-IRM	4		
3		Camara Exterior HK-DS2CE16C0T-IR	4		
4		Dvr 8ch - HK-DS7108HGHI-F1	1		
5		Disco Duro 100 GB	1		
6		Fuentes de alimentacion	8		
7		20 Metros de Cable	8		
Opciones de Pago:				SUBTOTAL	S/. 1,593.22
				IGV	S/. 286.78
				TOTAL A PAGAR	S/. 1,880.00

Codiciones y validez de la oferta:

30 dias

Validez:

Condiciones de entrega:

Entrega Inmediata

Condiciones de Garantía:

garantia de 1 año

Esperamos haber dado alcance a sus requerimientos

Cordialmente,

RICARDO TALAVERA

RPM: #999033365 RPC:959354677

DIRECCIONES

- Direccion: -Lima: Av Nicolas Arriola 265 Of. 201 (referencia: a 1 cuadra de Cruz del Sur de Javier Prado)

- Calle Rivero 107 of 302. Cercado - Arequipa

También estamos en:

Trujillo Puno Cajamarca - Piura -Tumbes - Ica - Chiclayo - Ayacucho- Tacna - Cusco

CUENTAS BANCARIAS :

INTEGRASAT SOLUCIONES CENTER SRL , RUC : 20455256357

Cuenta Corriente BCP Soles

215-2050250-0-12

Código interbancario: CCI: 00221500205025001225

Cuenta Corriente BCP DOLARES

215-2295979-1-31

Código interbancario: CCI 00221500229597913124

KIT11

8 CAMARAS DE METAL HD



CARACTERISTICAS DESCRIPTIVAS	
Material de la Camara	Metal
Caracteristica del DVR	8 Canales
CARACTERISTICAS NUMERICAS	
Resolucion de Camara	720P
Distancia Metros de Camara	20 metros
Capacidad de Disco Duro	100GB
capacidad de DVR	8 canales

ESPECIFICACIONES TECNICAS

HIKVISION

DS-2CE56C0T-IRM



Key Features

- 1.0 Megapixel high-performance CMOS
- Turbo HD output, up to 720P resolution
- True Day/Night
- DNR, Smart IR
- Up to 20m IR distance
- IP66 weatherproof

Specification

Model	DS-2CE56C0T-IRM
Parameter	720p IR Turbo HD Turret Camera
Camera	
Image Sensor	Progressive Scan CMOS
Effective Pixels	1280(H)*720(V)
Min. Illumination	0.01 Lux @(F1.2,AGC ON), 0 Lux with IR
Shutter Time	1/25(1/30) s to 1/50,000 s
Lens	3.6mm (2.8mm, 6mm optional) Angle of View: 71°(3.6mm), 92°(2.8mm), 57°(6mm)
Lens Mount	M12
Angle Adjustment	Pan: 0 - 360°, Tilt: 0 - 90°, Rotation: 0 - 360°
Day & Night	ICR
Synchronization	Internal synchronization
Video Frame Rate	720p@25fps/720p@30fps
HD Video Output	1 Turbo HD output
General	
Working Temperature/Humidity	-40 °C - 60 °C (-40 °F - 140 °F) Humidity 90% or less (non-condensing)

ESPECIFICACIONES TECNICAS

HIKVISION

Power Supply	12V DC
Power Consumption	Max. 4W
Weather Proof Ratings	IP66
IR Range	Up to 20m
Dimension	89.6 × 59.1 mm (3.53" × 2.33")
Weight(approx.)	240 g (0.54 lb)

Order Model

DS-2CE56C0T-IRM

Dimension

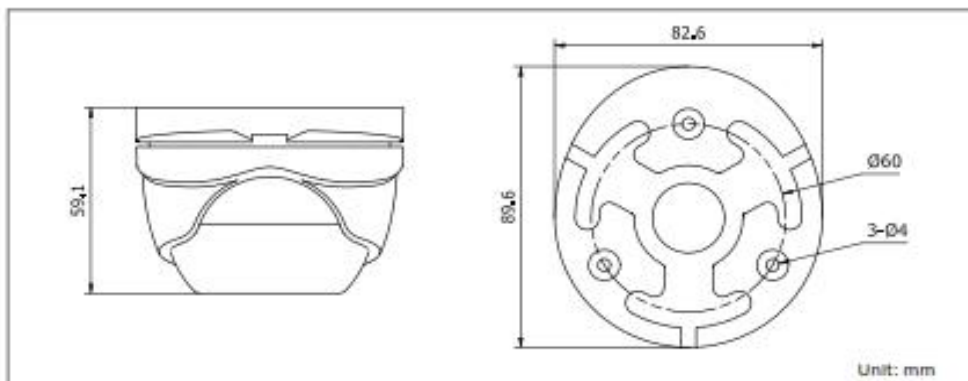

Accessories



Indoor/outdoor wall mount
DS-1272ZJ-110-TRS

ESPECIFICACIONES TECNICAS

HIKVISION

DS-2CE16C0T-IR



Key Features

- 1.0 Megapixel high-performance CMOS
- Analog HD output, up to 720P resolution
- True Day/Night
- DNR, Smart IR
- Up to 20m IR distance
- IP66 weatherproof

Specification

Model	DS-2CE16C0T-IR
Parameter	Turbo HD720p IR Bullet Camera
Camera	
Image Sensor	1MP CMOS Image Sensor
Effective Pixels	1296(H)*732(V)
Min. Illumination	0.1 Lux @(F1.2,AGC ON), 0 Lux with IR
Shutter Time	1/25(1/30) s to 1/50,000 s
Lens	3.6mm (2.8mm, 6mm optional)
	Angle of View: 70.9°(3.6mm), 92°(2.8mm), 56.7°(6mm)
Lens Mount	M12
Angle Adjustment	Pan: 0 - 360°, Tilt: 0 - 180°, Rotation: 0 - 360°
Day & Night	ICR
Synchronization	Internal synchronization
Video Frame Rate	720p@25fps/720p@30fps
HD Video Output	1 Analog HD output
S/N Ratio	> 62dB
General	
Working	-40 °C - 60 °C (-40 °F - 140 °F)

ESPECIFICACIONES TECNICAS

HIKVISION

Temperature/Humidity	Humidity 90% or less (non-condensing)
Power Supply	12V DC \pm 15%
Power Consumption	Max. 4W
Weather Proof Ratings	IP66
IR Range	Up to 20m
Dimension	Φ 70x149.5 mm (Φ 2.76" x5.89")
Weight	360g (0.79lb)

Order Model

DS-2CE16C0T-IR

Dimension

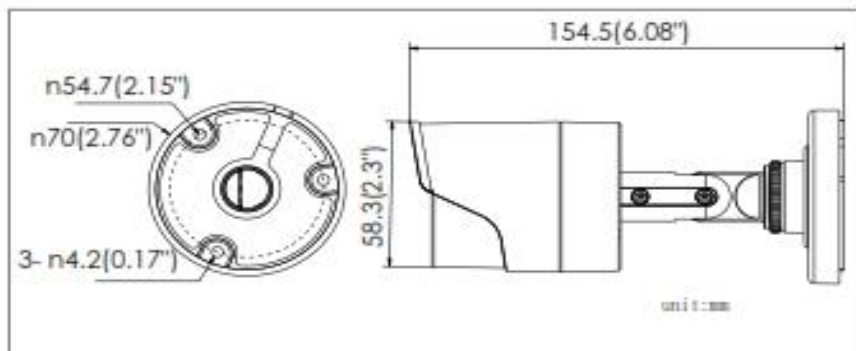

Accessory



DS-1280ZJ-XS
Junction box



DS-1H18
Video Balun



DS-TT-X41T
TVI Tester

ESPECIFICACIONES TECNICAS

HK-DS7108HGHI-F1



GRABADOR DE CAMARAS IP

Grabador de video de camaras IP de 4, 8, y 16 Canales NVR con conector HDMI soporta 1 Disco de hasta 4 TB.

Especificaciones

MODELO	HK-DS7108HGHI-F1
--------	------------------

Video

Sistema de video	BNC (1.0 Vp-p, 75 Ω), PAL / NTSC self-adaptive
Entrada de video	8CH/BCN
Capacidad	720P / VGA / Wd1 / 4CIF / CIF Soporta Analogo + HD-TVI + AHD

Grabaciones

Modo de Grabac	Manual > alarma > deteccion de mov. > Horario
Capacidad	VIDEO: 720P / VGA / Wd1 / 4CIF / CIF AUDIO: G.711u
Almacenamiento	HD, Internet
Busqueda	Hora, Calendario, Eventos, Canal.

Interface

BackUp	Internet , USB
Salida de Video	1HDMI/VGA: 1920x1080p- 1 BCN
Entrada/Salida de Audio	1CH RCA
Puerto de Internet	RJ45 10M/100M
Control PTZ	1rs-485 para control de domos PTZ
Puerto USB	2 USB
Disco Duro	1 Sata (Max. 4 TB)

General

Alimentacion	12VDC
Dimensiones	200 x 200 x 45 mm
Peso	≤0.8kg

Contenido



Guia de
Uso



Fuente
12V



Driver
H.264

Especificaciones

